

RECKERMANN FRÄSMASCHINEN

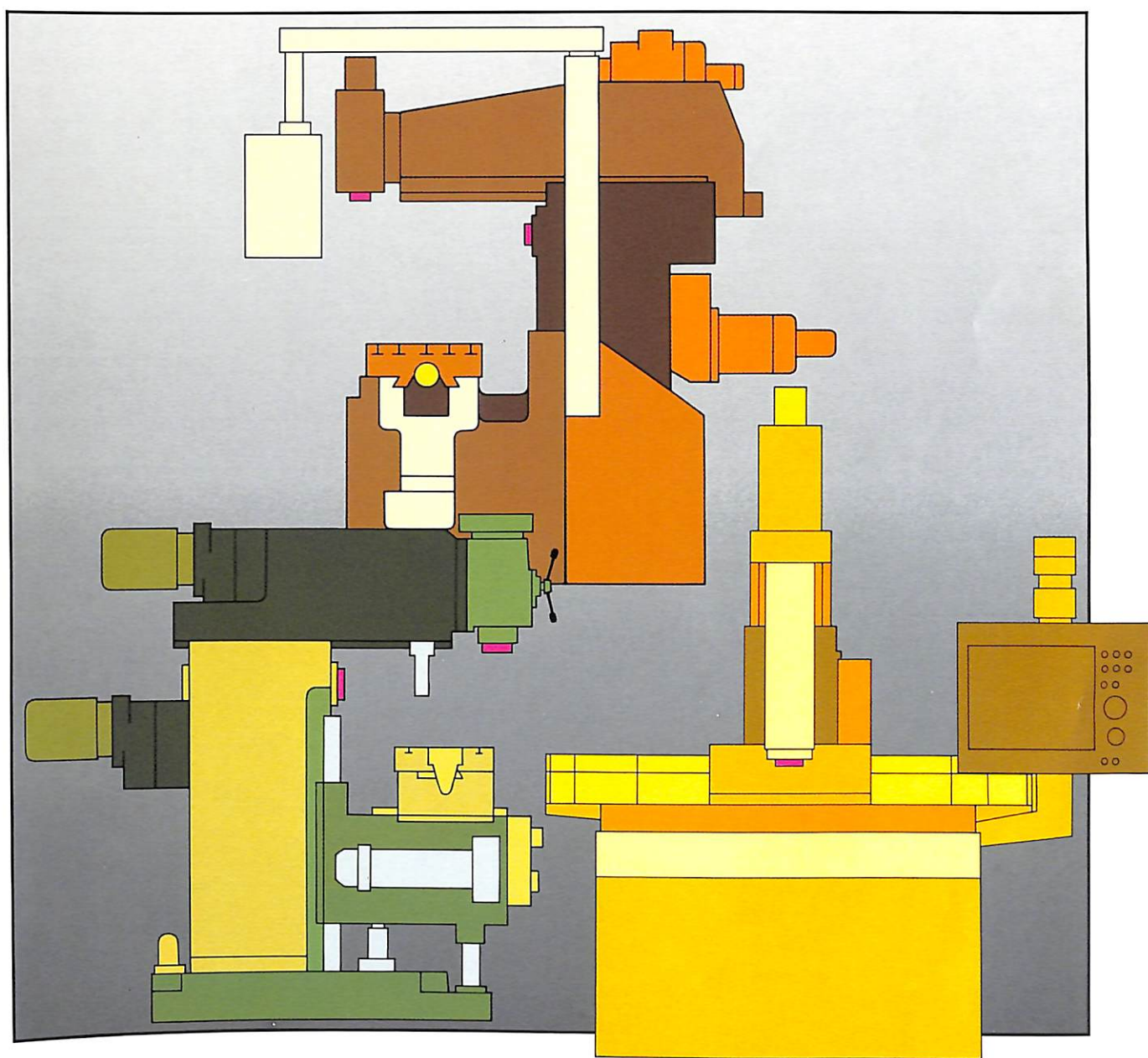

Programmübersicht

Bettfräsmaschinen

Baureihe

Frontansicht

Seitenansicht

Draufsicht

PRIMO II

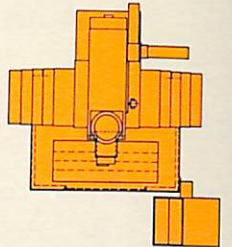
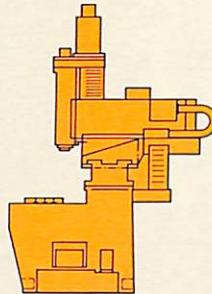
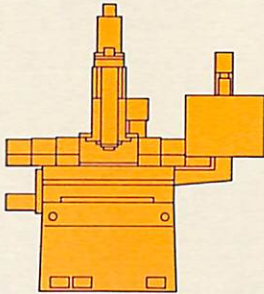

BETA 10

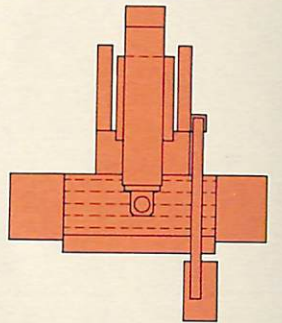
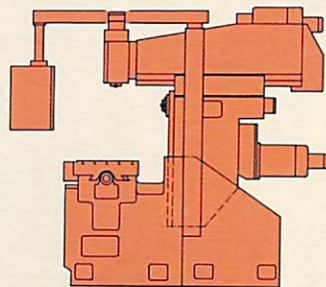
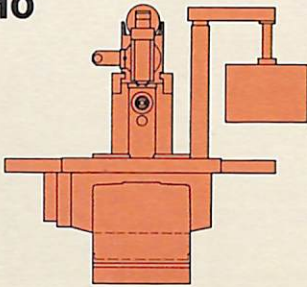

DELTA 1300

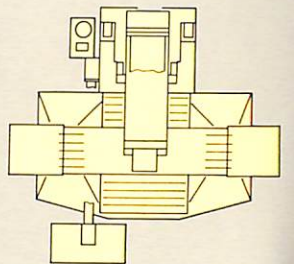
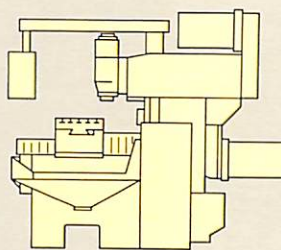
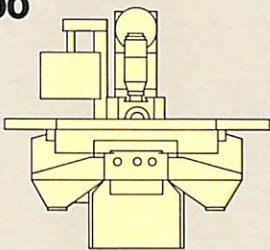

PLANO 20

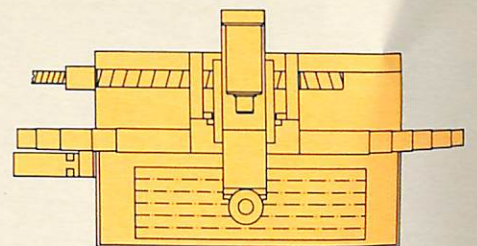
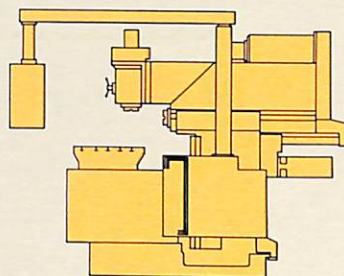
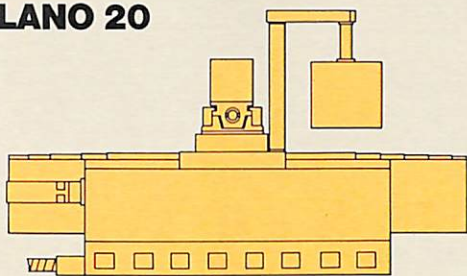

TRAVERSA 2000

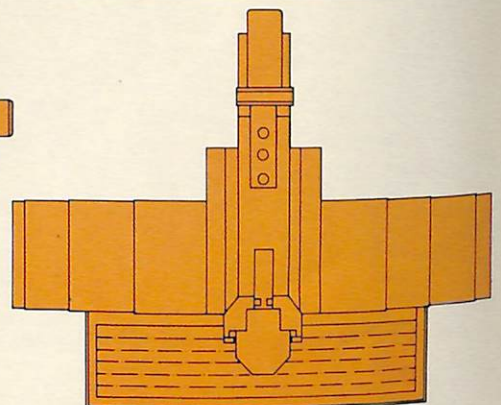
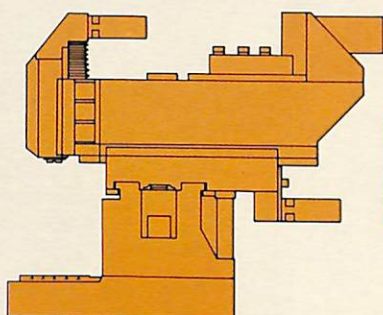
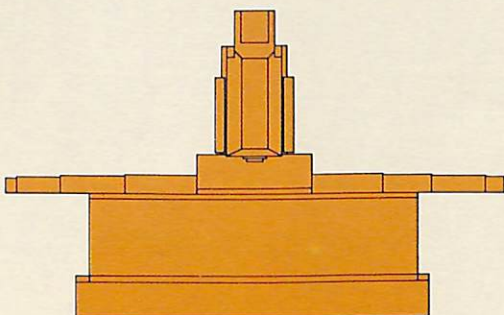



RECKERMANN FRÄSMASCHINEN

Bettfräsmaschinen

| Baureihe | | PRIMO II | BETA 10 | DELTA 1300 | PLANO 20 | TRAVERSA 2000 |
|-----------------------------------|--------|------------|------------------|---------------------|-------------------|---------------|
| Waagrecht-Frässpindel | | | | DELTA 1300 W | PLANO 20 W | |
| Senkrecht-Frässpindel | | ● | BETA 10 S | DELTA 1300 S | PLANO 20 S | ● |
| Kombiniert | | | BETA 10 KOMBI | DELTA 1300 KOMBI | PLANO 20 KOMBI | |
| Kombiniert mit Universalkopf | | | ○ | ○ | | |
| Aufspannfläche | mm | 800 x 300 | 1300 x 500 | 1300 x 400 | 2000 x 500 | 2100 x 900 |
| | Option | 1300 x 400 | 1800 x 500 | 1800 x 560 | 2000 x 600 | 2800 x 900 |
| | Option | 1800 x 400 | | | 2300 x 500 | 3600 x 900 |
| | Option | | | | 2300 x 600 | 2100 x 1200 |
| | Option | | | | | 2800 x 1200 |
| | Option | | | | | 3600 x 1200 |
| Längsweg x | mm | 600 | 1000 | 1000 | 1700 | 1500 |
| | Option | 1000 | 1500 | 1500 | 2200 | 2200 |
| | Option | 1500 | | | | 3000 |
| Querweg y | mm | 300 | 600 | 400 | 600 | 800 |
| | Option | | | | | 1100 |
| Senkrechtweg z | mm | 250 | 450 | 450 | 400 | 500 |
| Antriebsleistung (bei 60 % ED) | kW | 5,5 | 15 | 15 | 15 | 15 |
| | Option | | 20 | 20 | 20 | 20 |
| | Option | | | | | 22 |
| Werkzeugaufnahme | | ISO 40 | ISO 50 | ISO 50 | ISO 50 | ISO 50 |
| | Option | | ISO 40 | | | |
| NC-Streckensteuerung | | | | ○ | | |
| NC-Bahnsteuerung | | ● | ● | ○ | ● | ● |

- = Grundausstattung
- = Ausstattung gegen Mehrpreis



RECKERMANN
FRÄSMASCHINEN

Konsolfräsmaschinen

Baureihe

Frontansicht

Seitenansicht

Draufsicht

900 Pony

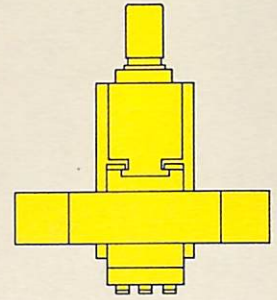
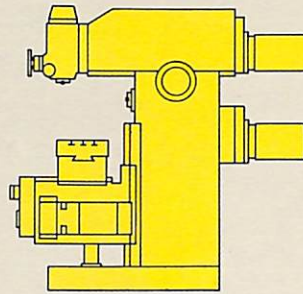
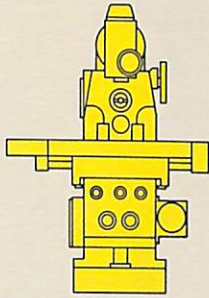

1000

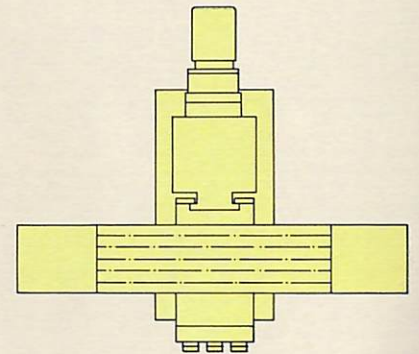
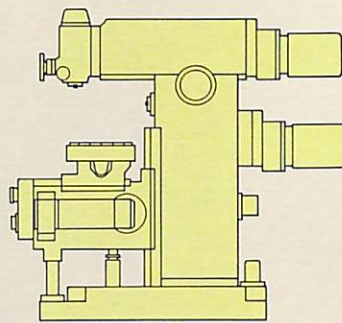
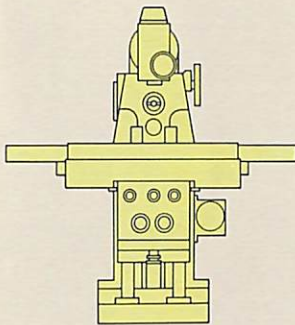

1050

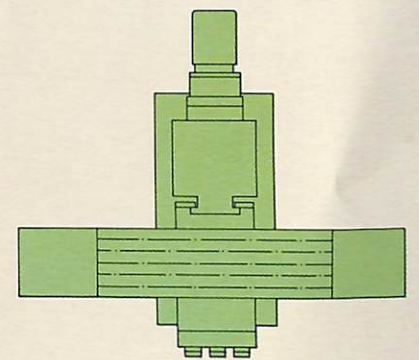
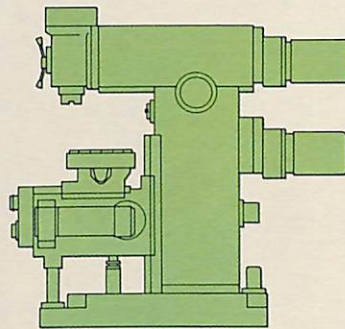
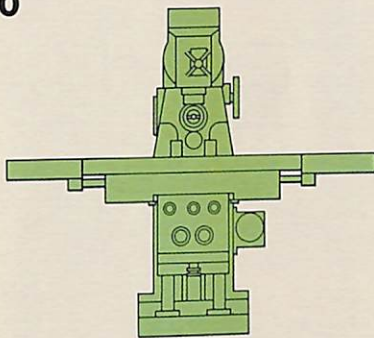

Sonderbauweise

Beispiel:
Duplex-
Fräsmaschine

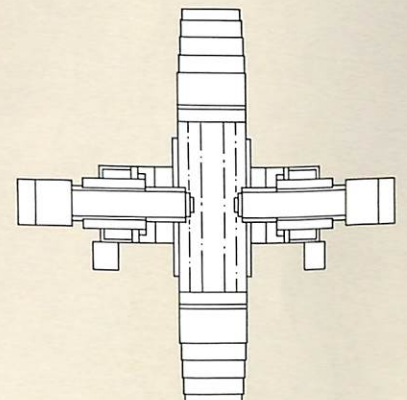
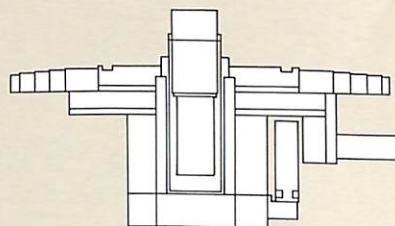
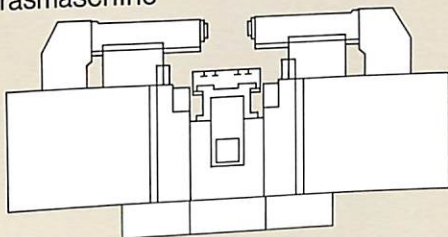



RECKERMANN
FRÄSMASCHINEN

Konsolfräsmaschinen

| Baureihe | | 900 Pony | 1000 | 1050 |
|---------------------------------|------------------------|---------------------------------------|--|--------------------------|
| Waagrecht-Frässpindel | | FW 900 | FW 1000 | FW 1050 |
| Senkrecht-Frässpindel | | FW 900 S | FW 1000 S | FW 1050 S |
| Kombiniert | | KOMBI 900 | KOMBI 1000 | KOMBI 1050 |
| Kombiniert mit Universalkopf | | UNI 900 | UNI 1000 | ○ |
| Tischgröße | mm Option Option | 900 x 315 1000 x 400 1300 x 400 | 1000 x 400 1300 x 400 1500 x 400 | 1300 x 400 1500 x 400 |
| Längsweg x | mm Option Option | 600 700 1000 | 700 1000 1200 | 1000 1200 |
| Querweg y | mm Option | 220 200 ¹⁾ | 370 | 370 |
| Senkrechtweg z | mm Option | 350 450 | 450 | 450 |
| Tisch schwenkbar | | ○ | ○ | ○ |
| Antriebsleistung je Spindel | kW Option | 3,2/4,0 4,0/5,5 | 4,0/5,5 6,1/7,4 | 14,5 (60 % DMC) |
| Werkzeugaufnahme | Option | ISO 40 ISO 50 | ISO 40 ISO 50 | ISO 50 |
| NC-Streckensteuerung | | ○ | ○ | ○ |

¹⁾ bei Tischbreite 400 mm
○ Ausstattung gegen Mehrpreis

Konstruktionsänderungen vorbehalten!

RECKERMANN FRÄSMASCHINEN

D-5650 Solingen · Postfach 10 03 23
Telefon (02 12) 65 81-0 · Telefax (02 12) 65 81 50 · Telex 8514639